

The Formwork Experts.

Column formwork Frami Xlife

Framed formwork Frami Xlife

User Information

Instructions for assembly and use (Method statement)

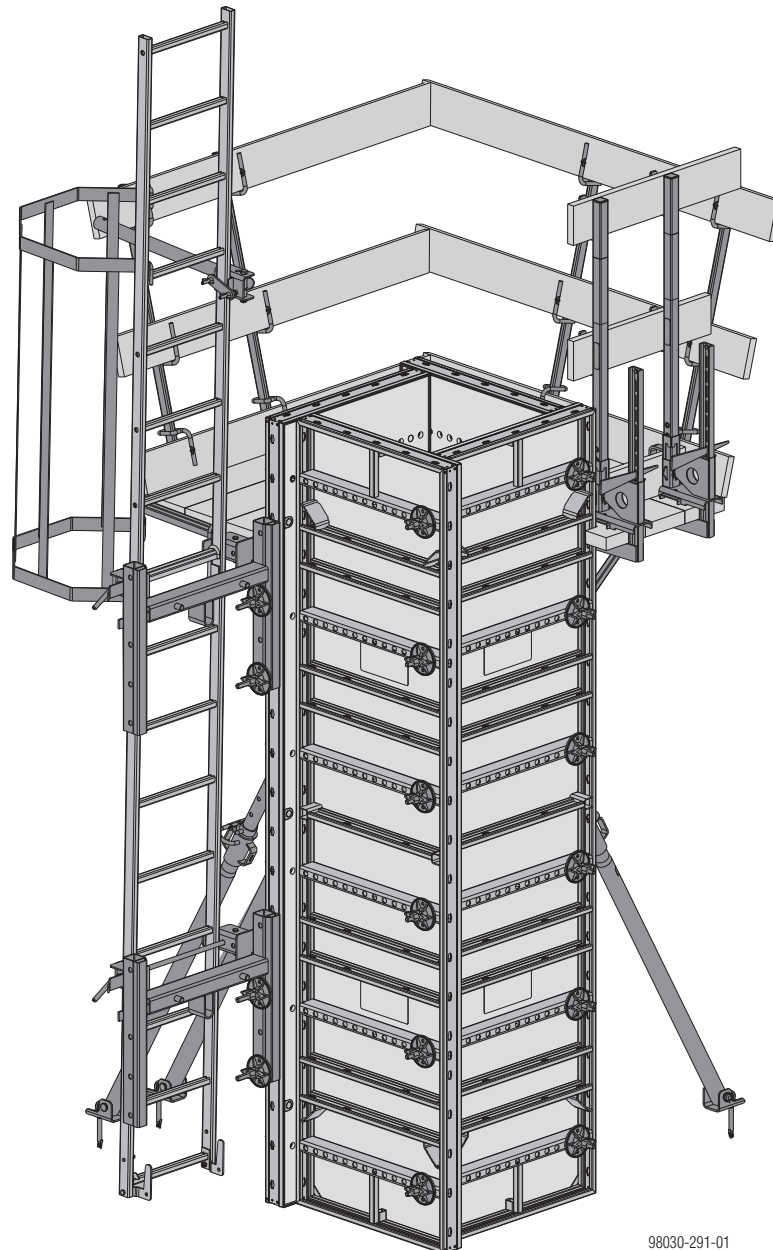

Contents

- 4 System description
- 5 with Frami Xlife universal panels
- 8 with Xlife universal panels and Xlife standard panels
- 10 with outside corners and Xlife panels
- 11 Pouring platforms with Frami bracket 60

System description

There are several different ways of using Frami Xlife framed formwork to make column formworks:

Permitted pressure of fresh concrete: **80 kN/m²**

- with **Xlife universal panels**
 - for flexible accommodation to column cross-sections of up to 80 x 80 cm, in a 5 cm grid
- combining **Xlife universal panels and standard Xlife panels**
 - is a highly economical solution for certain cross-sections of column
- with **Xlife panels and outside corners**
 - for the two dimensions of 30 cm and 45 cm



- To achieve exact plumbing & aligning of the column formwork, the best arrangement of the panel struts is as illustrated here.
- Always attach panel struts to free-standing formwork halves to prevent them from falling over.

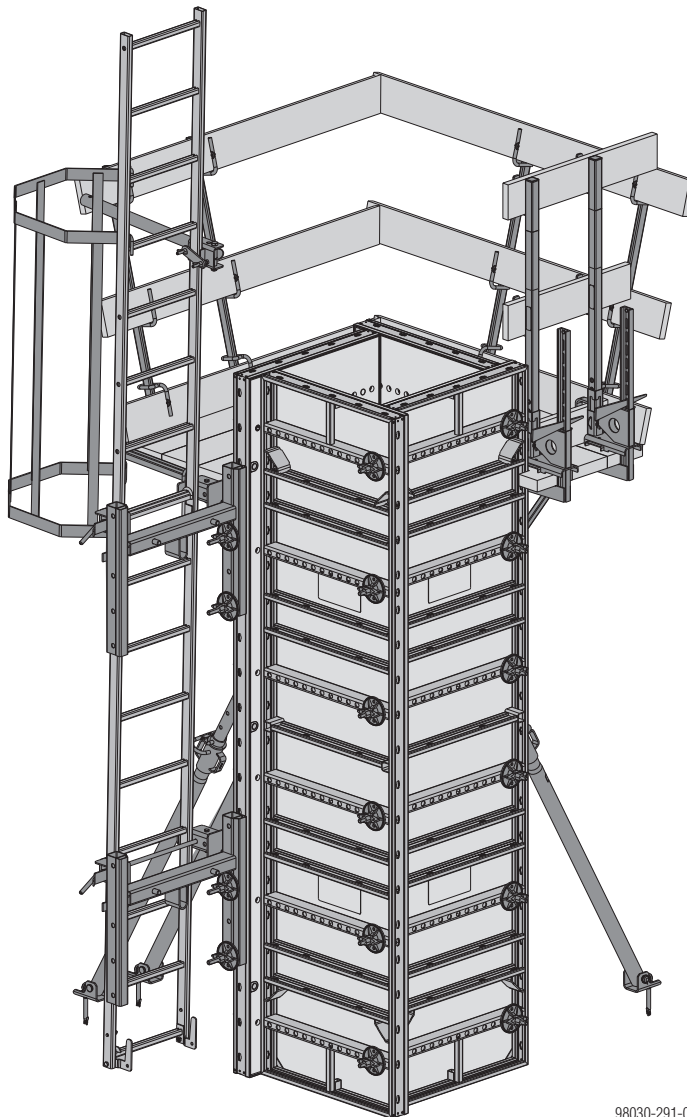

98030-291-01

Shown here on Frami Xlife panels 3.00m.



Important note:

This document is only valid in conjunction with the following underlying document(s):
'Framed formwork Frami Xlife' or 'Frami Xlife / Frami eco' User Information booklet!

with Frami Xlife universal panels

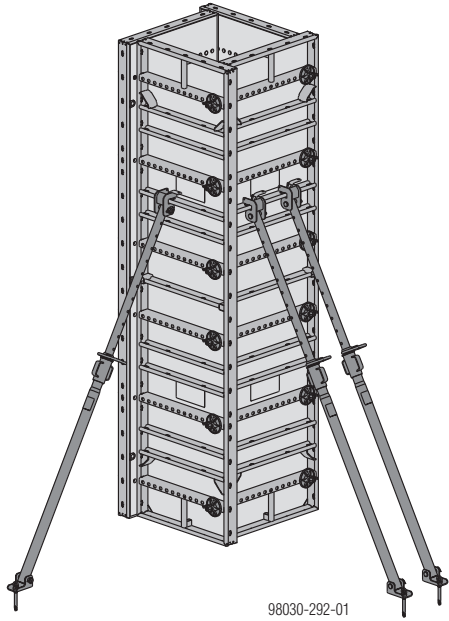

Shown here on Frami Xlife panels 3.00m.

The practical 5 cm hole-grid is ideal for forming columns.

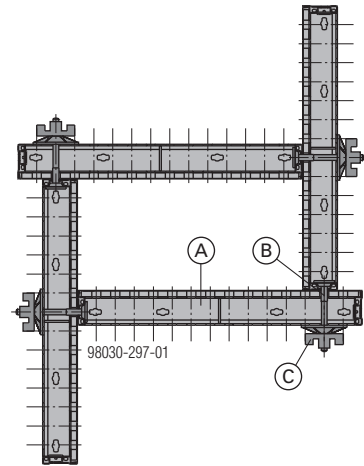

Example: Column 30 cm x 60 cm

- A Frami Xlife universal panel
- B Frami universal fixing bolt 5-12cm or Frami corner connector
- C Super-plate 15.0

Frami universal fixing bolts / Frami corner connectors:

Permitted tensile load: 15.6 kN (when used in Frami Xlife universal panels)

 Close off unneeded grid holes in the form-facing of the Frami Xlife universal panels with **Frami plugs**.

Frami Xlife universal panel 0.75m

for column cross-sections of up to 65 x 65 cm

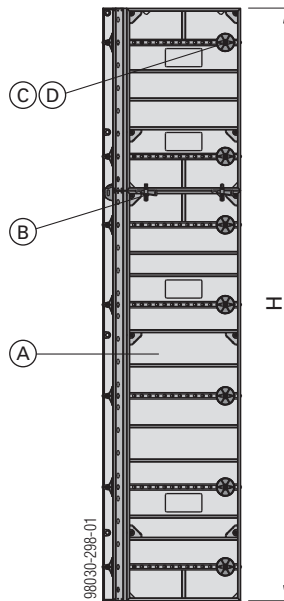

Schedule of materials

Combining panel heights 1.20m and 1.50m

Formwork height (H)	Xlife universal panels 0.75m (A)		Frami clamps (B)	Universal fixing bolts (C)	Super-plates 15.0 (D)
	1.20m	1.50m			
1.20m	4			8	8
1.50m		4		12	12
2.40m	8		8	16	16
2.70m	4	4	8	20	20
3.00m		8	8	24	24
3.60m	12		16	24	24
3.90m	8	4	16	28	28
4.20m	4	8	16	32	32
4.50m		12	24	36	36

Combining panel heights 1.20m, 1.50m and 2.70m

Formwork height (H)	Xlife universal panels 0.75m (A)			Frami clamps (B)	Universal fixing bolts (C)	Super-plates 15.0 (D)
	1.20m	1.50m	2.70m			
1.20m	4				8	8
1.50m		4			12	12
2.40m	8			8	16	16
2.70m			4		20	20
3.00m		8		8	24	24
3.60m	12			16	24	24
3.90m	4		4	8	28	28
4.20m		4	4	8	32	32

Combining panel heights 1.20m, 1.50m and 3.00m

Formwork height (H)	Xlife universal panels 0.75m (A)			Frami clamps (B)	Universal fixing bolts (C)	Super-plates 15.0 (D)
	1.20m	1.50m	3.00m			
1.20m	4				8	8
1.50m		4			12	12
2.40m	8			8	16	16
2.70m	4	4		8	20	20
3.00m			4		24	24
3.60m	12			16	24	24
3.90m	8	4		16	28	28
4.20m	4		4	8	32	32
4.50m		4	4	8	36	36

All figures in items.

Frami Xlife universal panel 0.90m

for column cross-sections of up to 80 x 80 cm

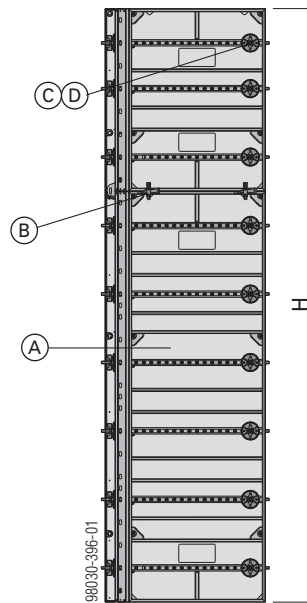

Schedule of materials

Combining panel heights 1.20m and 1.50m

Formwork height (H)	Xlife universal panels 0.90m (A)		Frami clamps (B)	Universal fixing bolts (C)	Super-plates 15.0 (D)
	1.20m	1.50m			
1.20m	4			12	12
1.50m		4		16	16
2.40m	8		8	24	24
2.70m	4	4	8	28	28
3.00m		8	8	32	32
3.60m	12		16	36	36
3.90m	8	4	16	40	40
4.20m	4	8	16	44	44
4.50m		12	24	48	48

Combining panel heights 1.20m, 1.50m and 2.70m

Formwork height (H)	Xlife universal panels 0.90m (A)			Frami clamps (B)	Universal fixing bolts (C)	Super-plates 15.0 (D)
	1.20m	1.50m	2.70m			
1.20m	4				12	12
1.50m		4			16	16
2.40m	8			8	24	24
2.70m			4		24	24
3.00m		8		8	32	32
3.60m	12			16	36	36
3.90m	4		4	8	36	36
4.20m		4	4	8	40	40

Combining panel heights 1.20m, 1.50m and 3.00m

Formwork height (H)	Xlife universal panels 0.90m (A)			Frami clamps (B)	Universal fixing bolts (C)	Super-plates 15.0 (D)
	1.20m	1.50m	3.00m			
1.20m	4				12	12
1.50m		4			16	16
2.40m	8			8	24	24
2.70m	4	4		8	28	28
3.00m			4		28	28
3.60m	12			16	36	36
3.90m	8	4		16	40	40
4.20m	4		4	8	40	40
4.50m		4	4	8	44	44

All figures in items.

with Xlife universal panels and Xlife standard panels

Certain cross-sections of column can be formed highly economically by combining Xlife universal panels and standard Xlife panels.

Possible cross-sections:

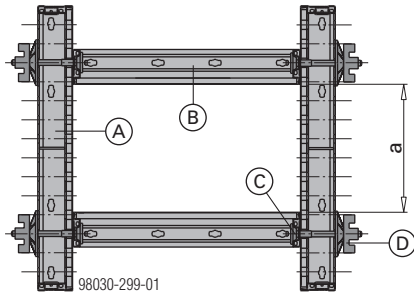

Example: Column 35 cm x 60 cm

	Dimension 'a'
Frami Xlife universal panel 0.75m	Up to 55 cm, in a 5 cm grid
Frami Xlife universal panel 0.90m	Up to 70 cm, in a 5 cm grid

(for constructional design reasons, a deviation of -1 cm is possible here)

- A Frami Xlife universal panel
- B Frami Xlife panel (max. 0.60m)
- C Frami universal fixing bolt 5-12cm or Frami corner connector
- D Super-plate 15.0
- E Frami clamp

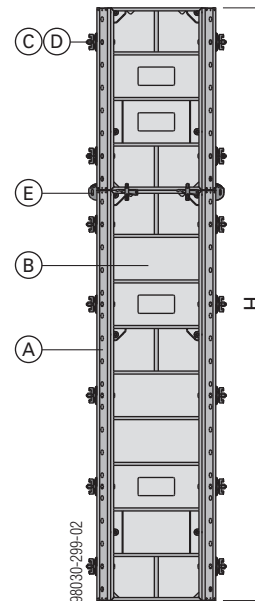

Frami Xlife universal panel 0.75m

Schedule of materials

Combining panel heights 1.20m and 1.50m

Formwork height (H)	Xlife universal panels 0.75m (A)		Panel (B)		Frami clamps (E)	Universal fixing bolts (C)	Super-plates 15.0 (D)
	1.20m	1.50m	1.20m	1.50m			
1.20m	2		2			8	8
1.50m		2		2		12	12
2.40m	4		4		8	16	16
2.70m	2	2	2	2	8	20	20
3.00m		4		4	8	24	24
3.60m	6		6		16	24	24
3.90m	4	2	4	2	16	28	28
4.20m	2	4	2	4	16	32	32
4.50m		6		6	24	36	36

Combining panel heights 1.20m, 1.50m and 2.70m

Formwork height (H)	Xlife universal panels 0.75m (A)			Panel (B)			Frami clamps (E)	Universal fixing bolts (C)	Super-plates 15.0 (D)
	1.20m	1.50m	2.70m	1.20m	1.50m	2.70m			
1.20m	2			2				8	8
1.50m		2			2			12	12
2.40m	4			4			8	16	16
2.70m			2			2		20	20
3.00m		4			4		8	24	24
3.60m	6			6			16	24	24
3.90m	2		2	2		2	8	28	28
4.20m		2	2		2	2	8	32	32

Combining panel heights 1.20m, 1.50m and 3.00m

Formwork height (H)	Xlife universal panels 0.75m (A)			Panel (B)			Frami clamps (E)	Universal fixing bolts (C)	Super-plates 15.0 (D)
	1.20m	1.50m	3.00m	1.20m	1.50m	3.00m			
1.20m	2			2				8	8
1.50m		2			2			12	12
2.40m	4			4			8	16	16
2.70m	2	2		2	2		8	20	20
3.00m			2			2		24	24
3.60m	6			6			16	24	24
3.90m	4	2		4	2		16	28	28
4.20m	2		2	2		2	8	32	32
4.50m		2	2		2	2	8	36	36

All figures in items.

Frami Xlife universal panel 0.90m**Schedule of materials****Combining panel heights 1.20m and 1.50m**

Formwork height (H)	Xlife universal panels 0.90m (A)		Panel (B)		Frami clamps (E)	Universal fixing bolts (C)	Super-plates 15.0 (D)
	1.20m	1.50m	1.20m	1.50m			
1.20m	2		2			12	12
1.50m		2		2		16	16
2.40m	4		4		8	24	24
2.70m	2	2	2	2	8	28	28
3.00m		4		4	8	32	32
3.60m	6		6		16	36	36
3.90m	4	2	4	2	16	40	40
4.20m	2	4	2	4	16	44	44
4.50m		6		6	24	48	48

Combining panel heights 1.20m, 1.50m and 2.70m

Formwork height (H)	Xlife universal panels 0.90m (A)			Panel (B)			Frami clamps (E)	Universal fixing bolts (C)	Super-plates 15.0 (D)
	1.20m	1.50m	2.70m	1.20m	1.50m	2.70m			
1.20m	2			2				12	12
1.50m		2			2			16	16
2.40m	4			4			8	24	24
2.70m			2			2		24	24
3.00m		4			4		8	32	32
3.60m	6			6			16	36	36
3.90m	2		2	2		2	8	36	36
4.20m		2	2		2	2	8	40	40

Combining panel heights 1.20m, 1.50m and 3.00m

Formwork height (H)	Xlife universal panels 0.90m (A)			Panel (B)			Frami clamps (E)	Universal fixing bolts (C)	Super-plates 15.0 (D)
	1.20m	1.50m	3.00m	1.20m	1.50m	3.00m			
1.20m	2			2				12	12
1.50m		2			2			16	16
2.40m	4			4			8	24	24
2.70m	2	2		2	2		8	28	28
3.00m			2			2		28	28
3.60m	6			6			16	36	36
3.90m	4	2		4	2		16	40	40
4.20m	2		2	2		2	8	40	40
4.50m		2	2		2	2	8	44	44

All figures in items.

with outside corners and Xlife panels

Column dimensions of **30 cm** and **45 cm** can also be formed using **outside corners** and **Xlife panels**.

Schedule of materials

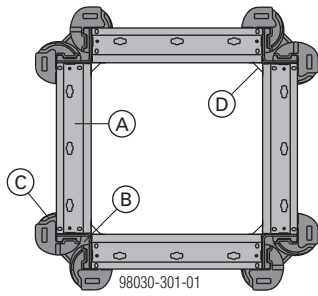

Example: Column 45 cm x 45 cm

- A** Frami Xlife panel (max. 45cm)
- B** Outside corner
- C** Frami clamp
- D** Triangular ledge

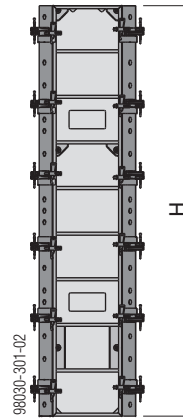

Example: Outside corners 2.70m with Xlife panels 0.45 x 2.70m

Panel height (H)	Panels (A)				Outside corners (B)				Frami clamps (C)
	1.20m	1.50m	2.70m	3.00m	1.20m	1.50m	2.70m	3.00m	
1.20m	4				4				24
1.50m		4				4			24
2.70m			4				4		48
3.00m				4				4	48

All figures in items.

Pouring platforms with Frami bracket 60

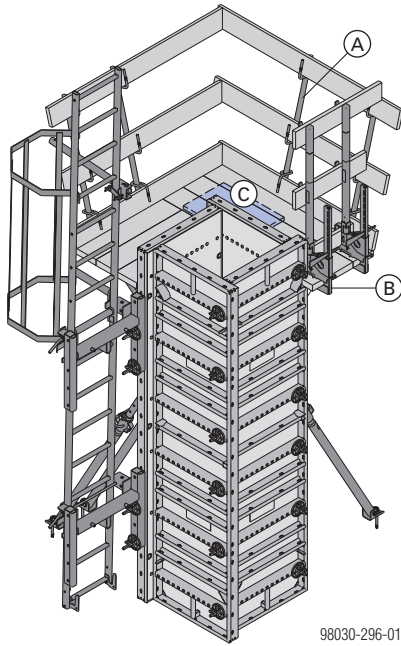



98030-296-01

- A Frami bracket 60 (deck and guard-rail boards provided at site)
- B Edge protection system XP (guard-rail boards provided at site)
- C Board for screwing the platform decking onto

Note:

Where the two platform planking units meet, a board must be screwed onto the underside.

 The brackets must be secured against accidental lift-out

 For more information, please refer to the 'Framed formwork Frami Xlife' or 'Frami Xlife / Frami eco' User Information booklets.

Near to you, worldwide

Doka is one of the world leaders in developing, manufacturing and distributing formwork technology for use in all fields of the construction sector.

With more than 160 sales and logistics facilities in over 70 countries, the Doka Group has a highly efficient distribution network which ensures that equipment and

technical support are provided swiftly and professionally.

An enterprise forming part of the Umdasch Group, the Doka Group employs a worldwide workforce of more than 5600.

